

Riba
Club armchair
by Kettal Studio

kettal

Club armchair

Designer
Kettal Studio

Collection
Triconfort Riba

Reference
KS4000500

1/3

This collection mixes ancestral techniques such as the braiding of natural fibres with aluminium, a material that had its heyday in the fifties. Now, the metal frame replaces traditional wood, while natural fibre has been replaced with a synthetic material in order to provide greater weather resistance.

cm/inch

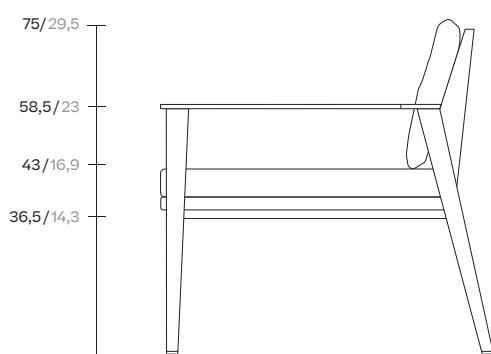

75/29,5
58,5/23
43/16,9
36,5/14,3

cm/inch | 77/30,3 |

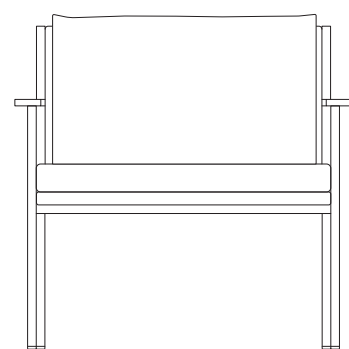

| 78/30,7 |



kettal

Club armchair

Designer
Kettal Studio

Collection
Triconfort Riba

Reference
KS4000500

2/3

Materials

Aluminium

Antioxy, Heavy Load, Resistant
En-1421, Kettalize-It, Anti-
Scratch, Easy Clean, Flame
Retardant M1, Eco Friendly
Ecoembes Recy-cling Process

Synthetic Fiber

Antioxy, Heavy Load, Resistant
En-1421, Kettalize-It, Anti-
Scratch, Easy Clean, Flame
Retardant M1, Eco Friendly
Ecoembes Recy-cling Process

Maintenance

Clean with mild soap using
sponge or cloth. Be gentle
while cleaning, do not scrub
aggressively the fabric. Once
cleaned please make sure you
remove soap excess.

In case of aggressive stains
clean with diluted household
bleach.

Clean stains promptly. The
longer it remains, more difficult
will be to remove.

Once cleaned the fabric steam
iron the fabric. Just use steam,
be carefull NOT placing the
iron directly in the fabric it will
get damage.

Frame Colour Options



Chalk
721



Bone
678



Tuff
103



Mist
773



Flint
734



London Clay
729



Mahogany
100



Carbon
737



Lilac
104



Feldspar
082



Sepia
088



Terra Rossa
087



Magma
086



Terracota
085



Sahara
139

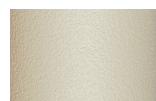

Camomile
106



Aquamarine
107



Cobalt
089

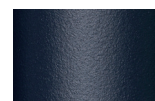

Indigo
094



Jade
091



Onyx
101



Juniper
092



Amazon
102



Bronze
093



Corten
727



Claystone
741

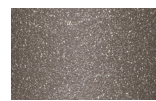

Sand Storm
132



Pumice
131



Galena
105



Manganese
726

Fibre Colour Options

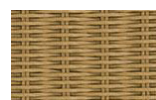

Natural Loom
000

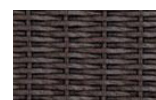

Chestnut
Fibre

Fibre

Club armchair

Designer
Kettal Studio

Collection
Triconfort Riba

Reference
KS4000500

3/3

Seat/Back Cushion Colour

Terrain Fabrics Laminate

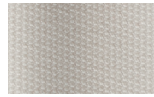

White Cliffs
290



Dry Sand
285

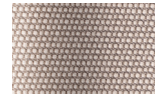

Porous Grey
291

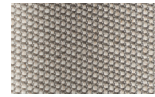

Limestone
292



Fog
289

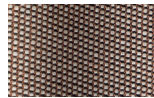

Deer
286



Wet Sand
287



Cobblestone
302



Cyprus Umber
301



Loam
297



Charcoal
293



Arctic
295

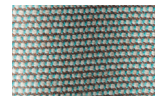

Fjord
248



Cerulean
314



Caribbean
298



Atlantic
311



Rainforest
312

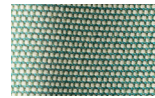

Lagoon
249



Cedar
288

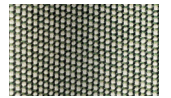

Moss
296

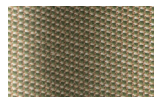

Olive
313

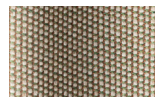

Autumn
315

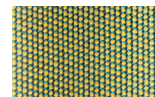

Summer Sky
317

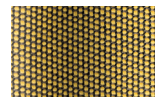

Golden Sand
303



Flamma
304

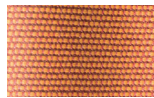

Sunrise
299



Saffron
305



Burnt Sienna
306

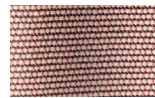

Ash Rose
294

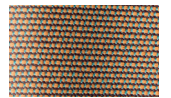

Cooper
316

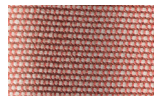

Dusk Pink
307

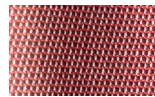

Flamingo
310



Coral
309



Sandstone
308