

Basics
Club armchair
Everyday
by Kettal Studio

kettal

Club armchair

Designer
Kettal Studio

Collection
Triconfort Basics

Reference
KS1400200

1/3

This design comes from the traditional chairs made of bulrush (Enea) this universal design is very common in different parts of the world: from Mediterranean areas until places in north of Europe.

Throughout the years many updates designs have been made: wood, plastic. Triconfort enea it's an outdoor version made in aluminium with synthetic fibers.

cm/inch

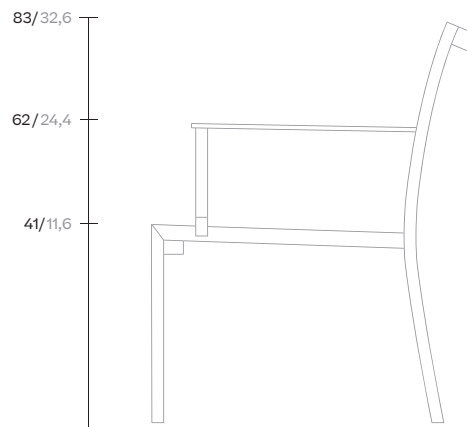

83/32,6

62/24,4

41/11,6

cm/inch

67/26,3

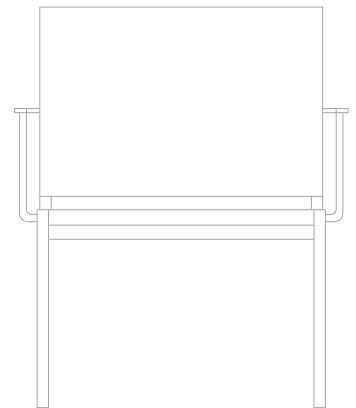

67/26,3



kettal

Club armchair

Designer
Kettal Studio

Collection
Triconfort Basics

Reference
KS1400200

2/3

Materials

Porotex Fabric
Heavy Load 100.000 Cycles,
Heavy Load Resistant 1000
Decitex, Kettalize-It, Resist U.v.
En-581-4, Easy Clean, Abrasion,
Resistance 30.000 Cycles,
Quickdry

Aluminium
Antioxy, Heavy Load, Resistant
En-1421, Kettalize-It, Anti-
Scratch, Easy Clean, Flame
Retardant M1, Eco Friendly
Ecoembes Recycling Process

Maintenance

Clean with mild soap using
sponge or cloth. Be gentle
while cleaning, do not scrub
aggressively the fabric. Once
cleaned please make sure you
remove soap excess.

In case of aggressive stains
clean with diluted household
bleach.

Clean stains promptly. The
longer it remains, more difficult
will be to remove.

Once cleaned the fabric steam
iron the fabric. Just use steam,
be carefull NOT placing the
iron directly in the fabric it will
get damage.

Frame Colour Options

Terrain Paints



Chalk
721



Bone
678



Tuff
103



Mist
773



Flint
734



London Clay
729



Mahogany
100



Carbon
737



Lilac
104



Feldspar
082

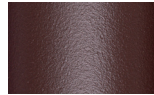

Sepia
088



Terra Rossa
087

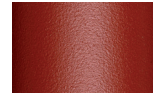

Magma
086



Terracota
085



Sahara
139



Camomile
106



Aquamarine
107



Cobalt
089

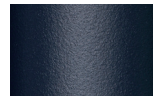

Indigo
094



Jade
091

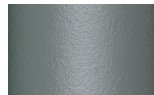

Onyx
101



Juniper
092



Amazon
102

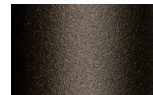

Bronze
093



Corten
727



Claystone
741



Sand Storm
132



Pumice
131



Galena
105



Manganese
726

Club armchair

Designer
Kettal Studio

Collection
Triconfort Basics

Reference
KS1400200

3/3

Other Characteristics



Stackable 4u.

Fabric Colour Options

Porotex Parallel Fabrics

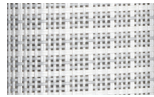

White Anemone
527

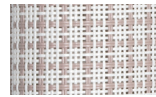

Lace Coral
528

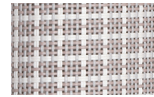

Padina
564

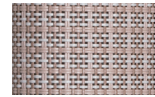

Saline
571

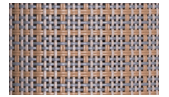

Alaria
572

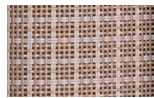

Sponge
536



Fucus
537

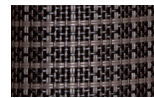

Urchin
547



Kelp
556

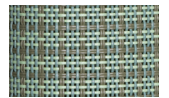

Turtle Grass
553

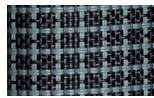

Deep Ocean
570

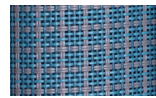

Winter Sea
569

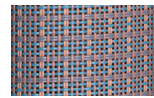

Xenia
568



Plumaria
567

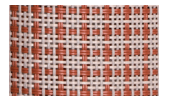

Irish Moss
559



Coral
562

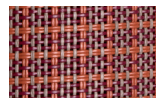

Dulse
565